



Electrolux
PROFESSIONAL

Standard Preparation 1200 mm Cupboard Sink with 2 Bowls

ITEM # _____

MODEL # _____

NAME # _____

SIS # _____

AIA # _____



132820 (MLA1225PN)

Cupboard Sink with 2 bowls
500x500mm and 2 sliding
doors, 1200mm

Short Form Specification

Item No. _____

Made entirely from stainless steel. Inner welded frame in stainless steel. Unique connection of panels to inner frame. The 50mm high worktop in 304 AISI stainless steel, 1mm in thickness, incorporates a layer of sound deadening material and has upturned edges. Upstand (h=100mm) with 8mm rounded edge. Sound-deadened sliding doors. Base panel in 304 AISI stainless steel and height-adjustable intermediate shelf. Sink bowls in 304 AISI stainless steel with overflow pipe and drain hole. Mounted on feet, adjustable in height.

Main Features

- Sturdiness, stability and reliability of table accurately tested.

Construction

- Inner welded frame in stainless steel to guarantee superior strength and stability.
- Easy access to the cupboard interior on all lengths guaranteed by the use of only 2 doors.
- Reinforced side and base panel in 304 AISI stainless steel.
- 304 AISI stainless steel feet, 200 mm high and 54 mm in diameter, adjustable by -50/+30 mm.
- Sturdy sound-deadened sliding doors on tracks located flush to the front of the frame.
- 100 mm upstand with 10 mm radiused corner and 13 mm deep, designed to be used against a wall.
- 50 mm worktop in 304 AISI stainless steel, 10/10 in thickness with overflow rim along the top.
- Wide range of taps are available to suit every need.

Optional Accessories

- Wheel kit for cupboards, 4 wheels (2 with brakes), D=100 mm PNC 855299
- Elbow operated mixer tap with spout 3/4", single hole PNC 855322
- Elbow operated mixer tap with short spout 3/4", single hole PNC 855323
- Foot operated mixer tap (hot and cold) with spout 3/4" PNC 855328
- Single plastic drain syphon 2" for Sinks PNC 895313

APPROVAL: _____



Experience the Excellence
www.electroluxprofessional.com

Key Information:

Cabinet width:		
132820 (MLA1225PN)	1145 mm	
Cabinet depth:	645 mm	
Cabinet height:	380 mm	
External dimensions, Width:	1200 mm	
External dimensions, Depth:	700 mm	
External dimensions, Height:	1000 mm	
Upstand Dimensions, Height:	100 mm	
Upstand Dimensions, Depth:	13 mm	
Upstand Dimensions, Radius:	R=10	
Bowls number	2	
Bowl dimensions	500x500xH300	
Number and type of doors:	2 Sliding	
Worktop thickness:	50 mm	
Net weight:	55 kg	

Front

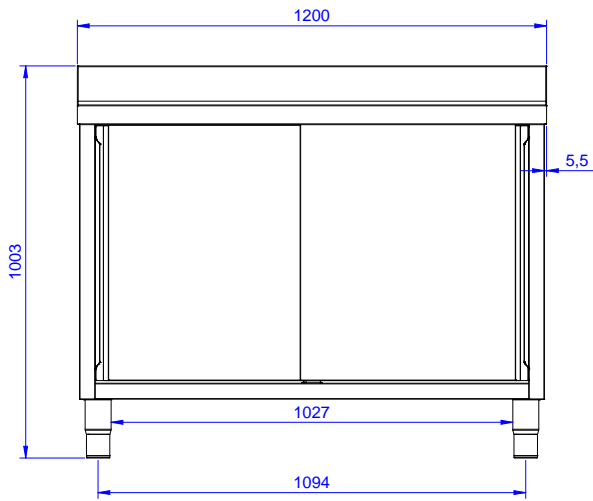

Side

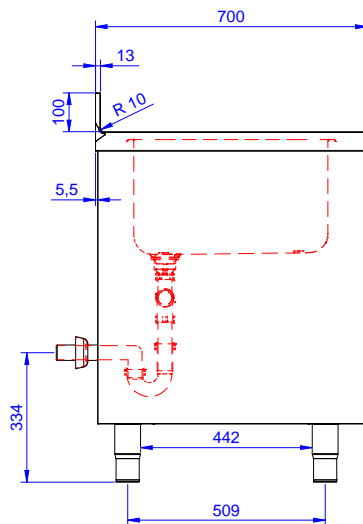

D = Drain

Top

